

CORNICE

WAREHOUSE

Unit 1, Midline Business Park
Cnr Le Roux Avenue & Richards Drive,
Halfway House, Midrand

010 443 6462 / 078 6611 468

CATALOGUE

CORNICES



SKIRTINGS



PVC CEILINGS

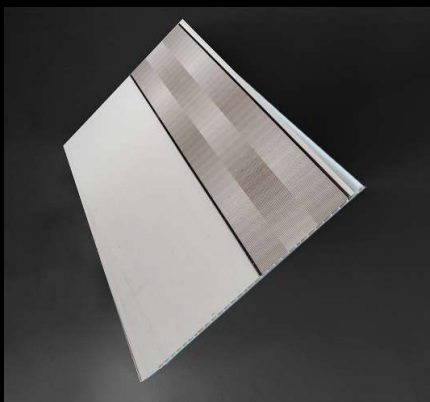

DADO RAILS



SKIRTINGS

- **Polymer Skirtings**



Locally manufactured and fully recyclable



Waterproof



Termite and insect proof



Maintenance free – will never warp, bend or distort



Easily installed



Durable and are long lasting quality with consistent finishes



Available in a wide range of colours and finishes.

CORNICE
WAREHOUSE

NEW RELEASE

**POLYMER
SKIRTINGS**

**NEW
NEW
NEW
NEW**

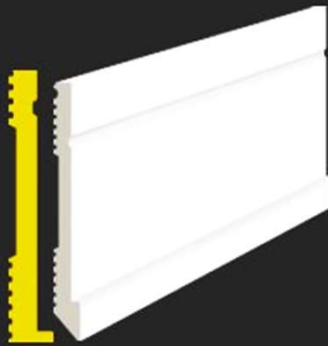

165mm Quality
Polymer Skirting



138mm Quality
Polymer Skirting

**CORNICE
WAREHOUSE**



CORNICE
WAREHOUSE

S134
138mm x 2.7m

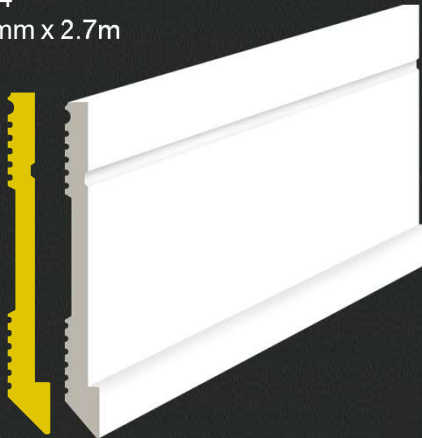

S165
165mm x 2.7m



Polymer Skirtings

- 138mm Quality Polymer Skirting

- 165mm Quality Polymer Skirting

S121
120mm x 2.7m



S753
75mm x 2.7m

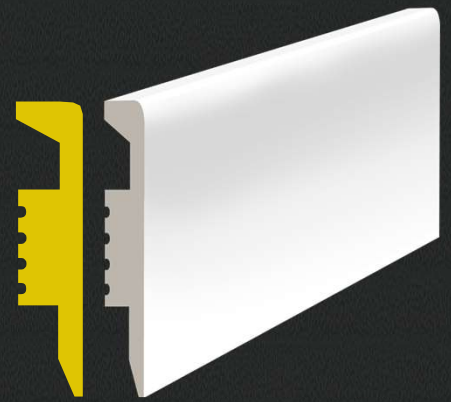

**120mm Quality
Polymer Skirting**

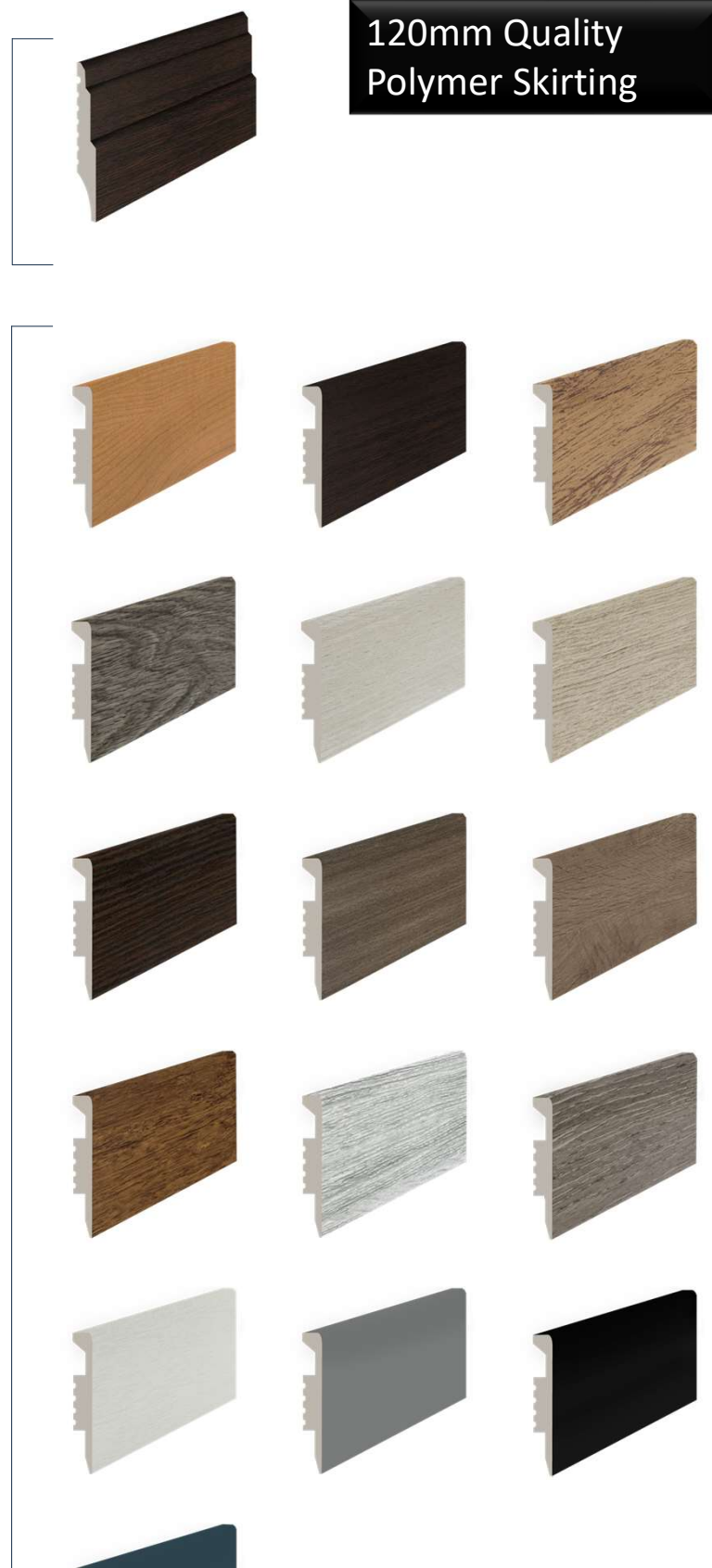

**75mm Quality
Polymer Skirting**

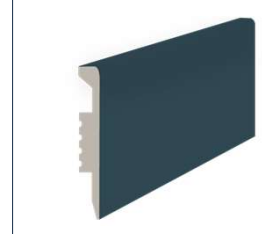

S103
1043mm x 2.7m

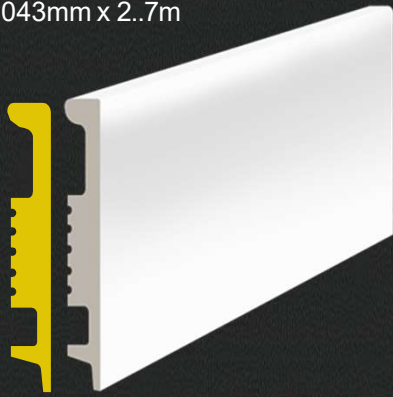

103mm BN Quality Polymer Skirting

S90
90mm x 2.7m

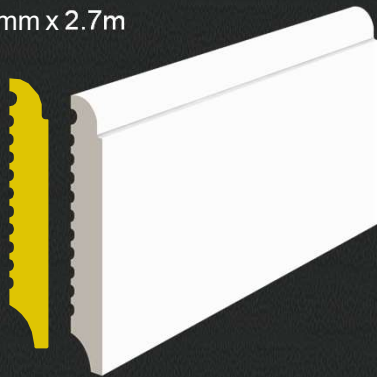

90mm Polymer BN 2.7 skirting White

S701
70mm x 2.7m



970mm Polymer Scallop 2.7 skirting

S101
100mm x 2.7m

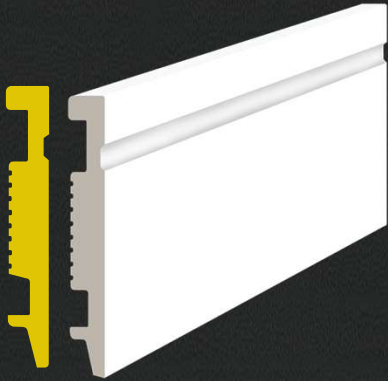

100mm Shadowline Polymer
Skirting

3026N
85mm x 12mm

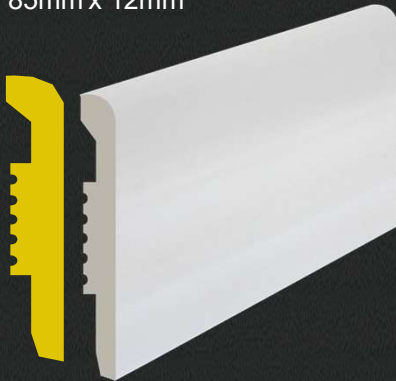

3026N 85mm Natural Paintable
Skirting

S751 Effects
75mm x 2.7m

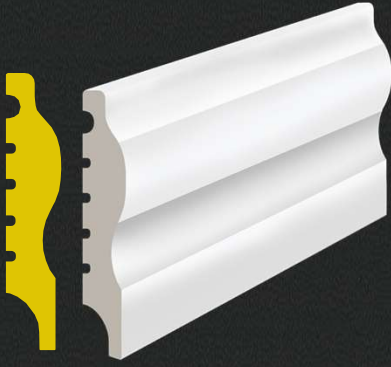

75mm Effects Quality Polymer Skirting

S152
150mm x 2.7m



150mm Quality Polymer Skirting

Cleat Skirtings

S Cleat
45mm
45mm x 2.7m

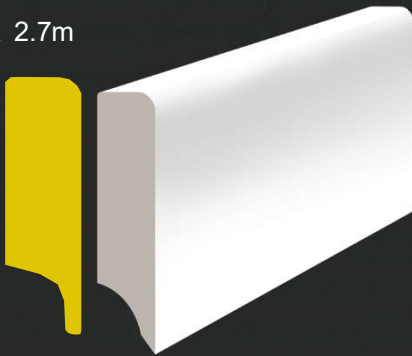

45mm Cleat Polymer Skirting

S Cleat 75mm
75mm x 2.7m

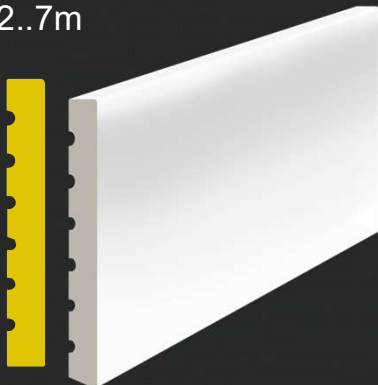

75mm Polymer Cleat Skirting

SK90 & 150 - Bello

90mm x 14mm 2.5m



SK90 - Bello

90mm x 14mm 2.5m



SK150 - Bello

150mm x 14mm 2.5m

SK90 Polymer Skirting
SK150 Polymer Skirting

SD581 & SD582 70mm & 100mm

SD581 - 70 & SD 100 Deco
Skirtings 70mm & 100mm
70mm/100mm x 2.7m



SD581 Polymer Skirting
70mm - 2.7m
100mm - 2.7m



SD582 - 70 & SD 100 Deco
Skirtings 70mm & 100mm
70mm/100mm x 2.7m

MANY COLOURS TO CHOOSE FROM!



SD582 Polymer Skirting
70mm - 2.7m
100mm - 2.7m

CORNICES

OUR CORNICES ARE
MANUFACTURED
FROM HIGH DENSITY
XPS POLYSTYRENE

- **Classical XPS
Cornice**

XPS is a high-density polystyrene aimed at the professional installer who is looking for a thicker more rigid cornice with a beautiful smooth finish, this would usually need only one coat of paint and it is ready to install.

- **LED Cornice**

Cornice warehouse has designed and developed the very first cornices and uplighters in South Africa to accommodate LED strip lighting.

Classic XPS Cornices

- Amber
- Topaz
- Amethyst
- Jade
- Jasper
- Opal
- Sapphire
- Shadow
- Step 3
- Caesar
- Cove
- Ruby
- Emerald



- 75mm XPS High Density
- 100mm XPS High Density
- 140mm XPS High Density
- 180mm XPS High Density

AMETHYST

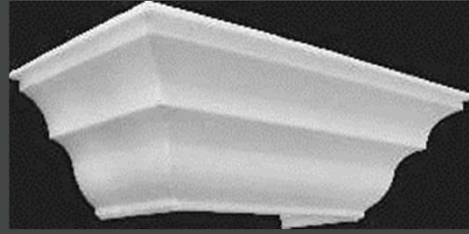
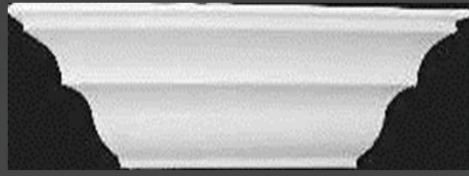

Amethyst 140 mm

Amethyst 100 mm

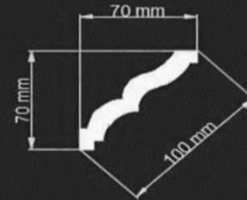
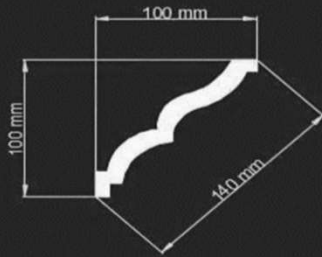

SAPPHIRE

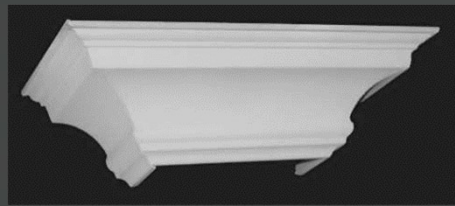
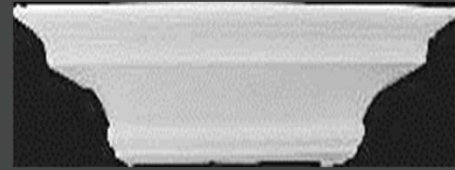

Sapphire 180 mm

Sapphire 140 mm

Sapphire 100 mm

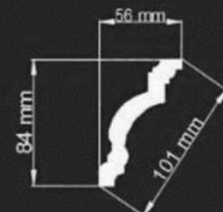
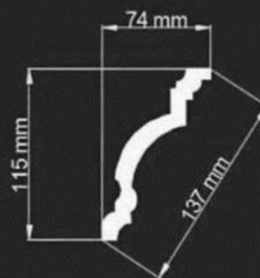
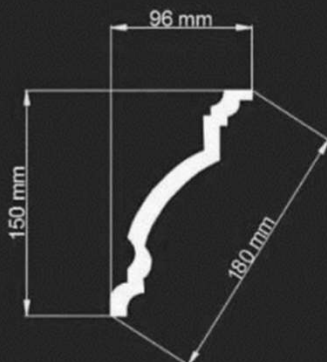

STEP 3

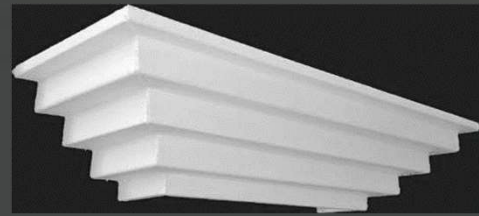

Step 3

110 mm

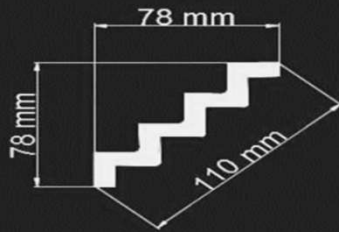

135 mm

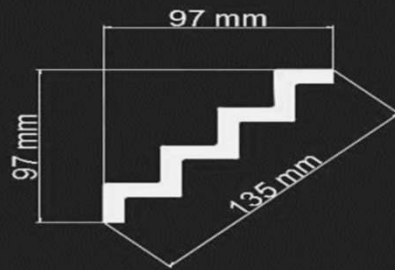

TOPAZ

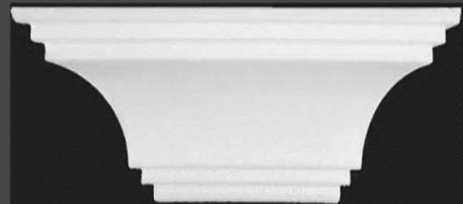

Topaz 110 mm

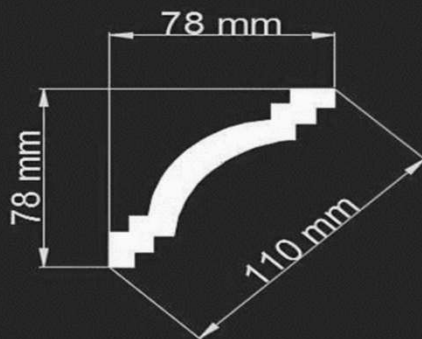

Topaz 140 mm

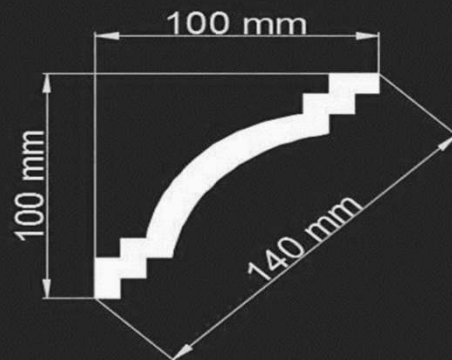

QUARTZ

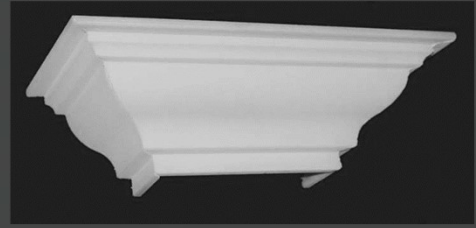
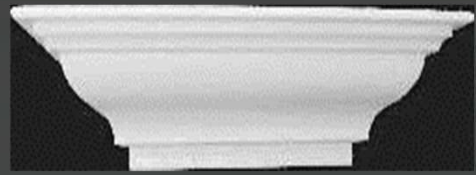

Quartz 100 mm

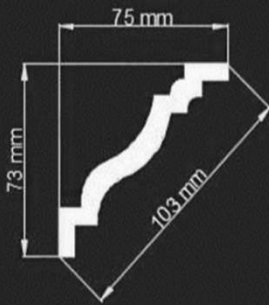

Quartz 140 mm

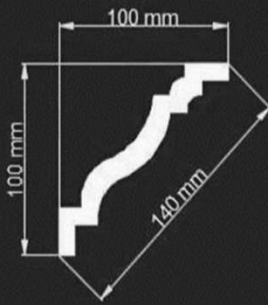

Quartz 180 mm

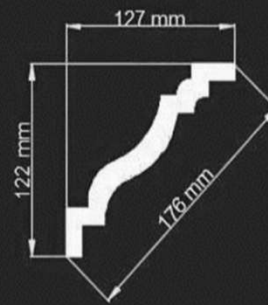

COVE

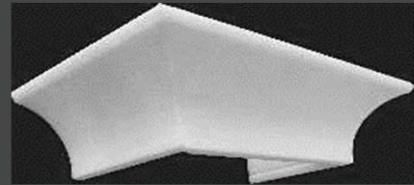

Cove 140mm

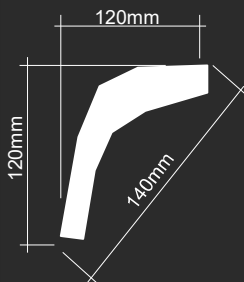

Cove 110mm

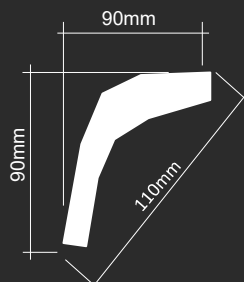

Cove 75mm

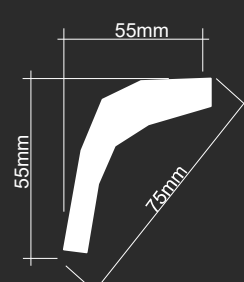

AMBER

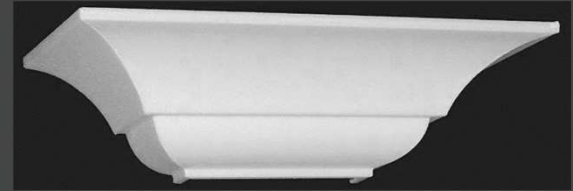

Amber 140 mm

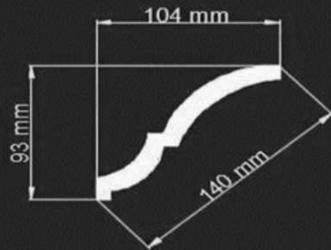

Amber 180 mm

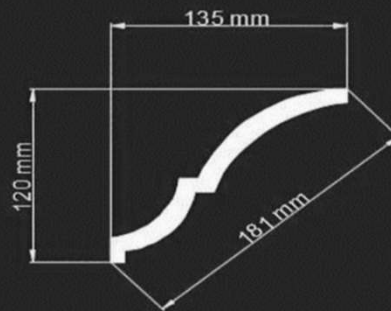

CAESAR

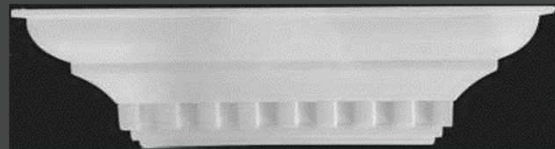

Caesar - 135 mm

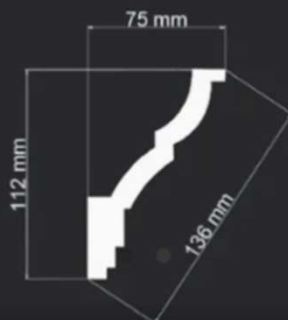

JADE



SHADOW



Jade 140 mm

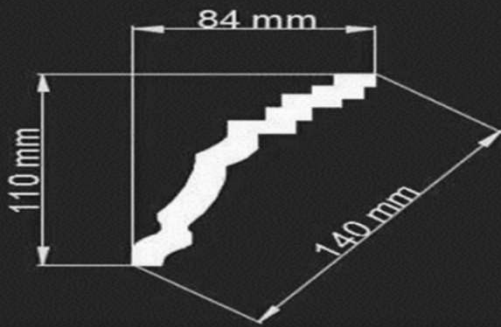

59 mm

35 mm

69 mm

RUBY

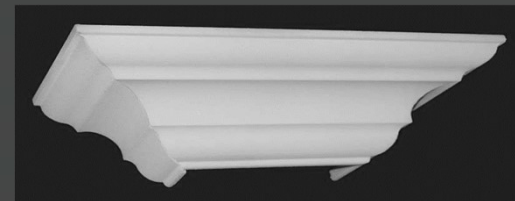

Ruby 180 mm

Ruby 140 mm

Ruby 100 mm

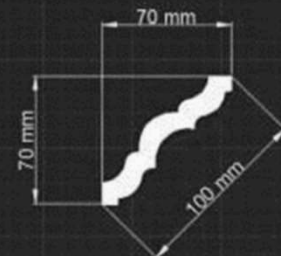
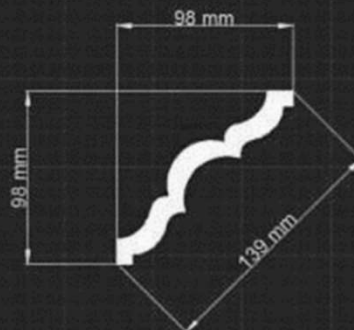
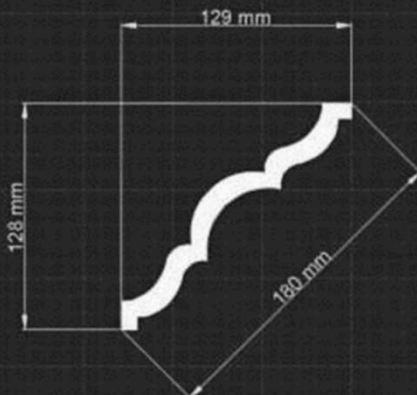

OPAL



POPULAR



Opal 180 mm

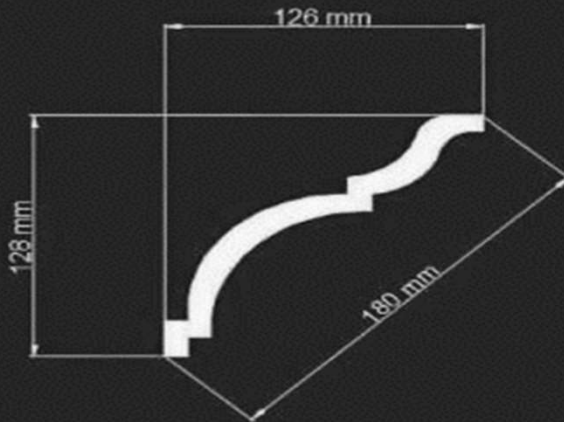

Opal 140 mm

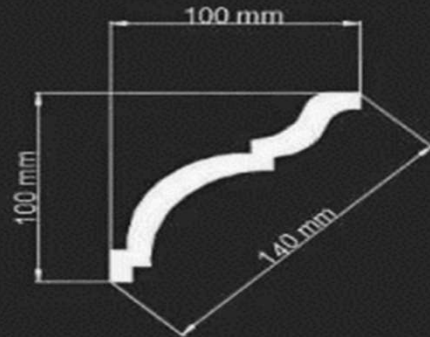

Opal 100 mm

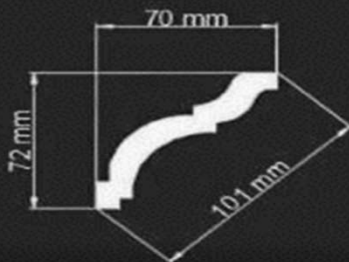

Opal 76 mm

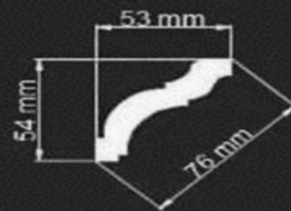

JASPER

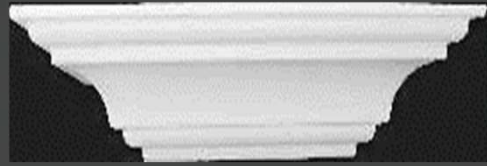

Jasper 76 mm

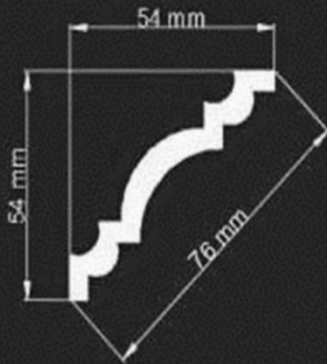

Jasper 100 mm

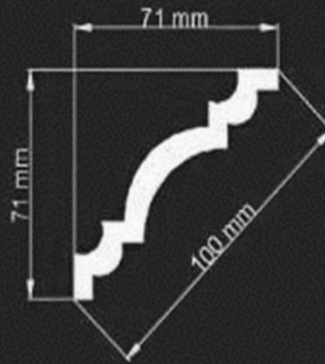

Jasper 120 mm

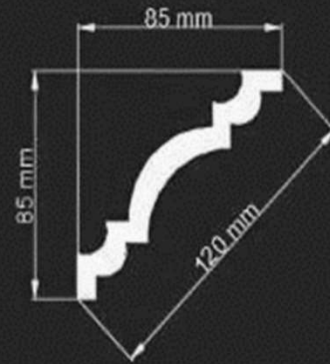

Jasper 140 mm

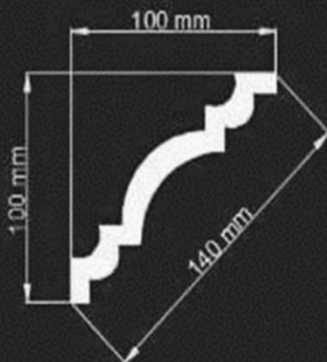

Jasper 180 mm

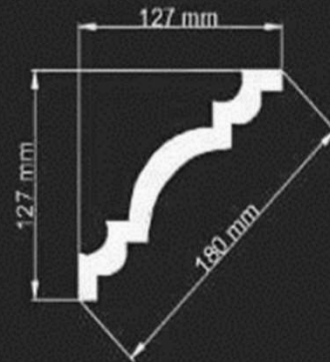

LED and uplighter Range

Manufactured from high density polystyrene, our cornices and uplighters are affordable, always in stock, and extremely easy to install. From single walls requiring some accent lighting to entire homes wanting a cornice with concealed lighting, our range brings this within easy reach of everyone.

LED

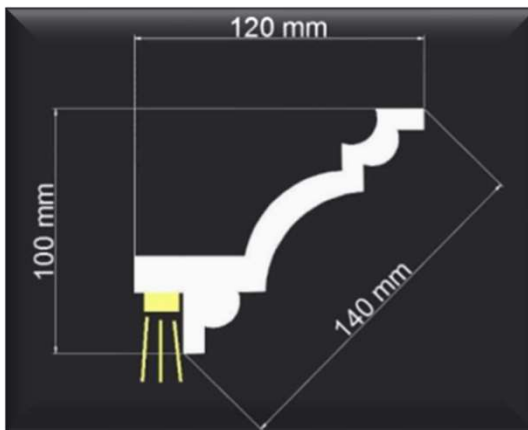

Based on the same design as our top selling Jasper cornice. Installs the same as a standard cornice but with the option of installing strip lighting.

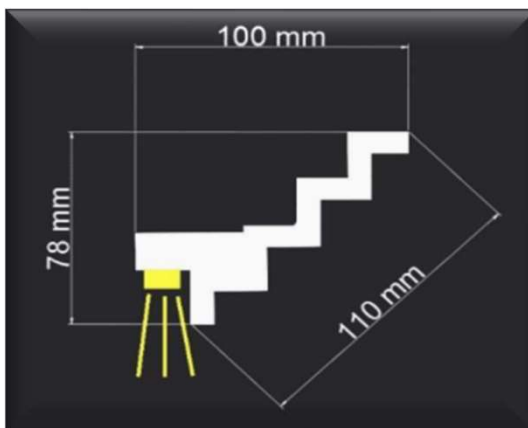

Based on the same design as our top selling Step 3 cornice.

UPLIGHTER

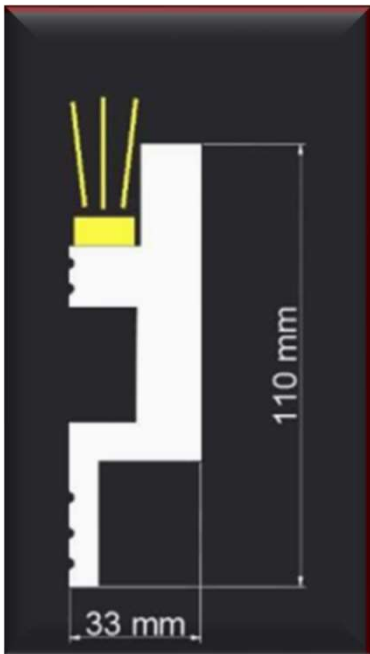

A stunning addition to the lighting in your home!

Please note that these are NOT cornices, as they do not go all the way to the ceiling. They are for mood lighting and throw a lovely wash of light onto your ceilings.



Dado Rails

**Polyurethane and Stone Dado
Rails are the perfect finish to
your home!**

These classic rails and architraves have a superior smooth finish, are water resistant, paintable and easy to install. These can be used as an architrave or as a decorative wall or ceiling finish.

1. Plain Dado Rails

Dado -14308

2.4mm x 62mm

Dado -14314

2.4mm x 52mm

Dado – 16541

2.4mm x 97mm

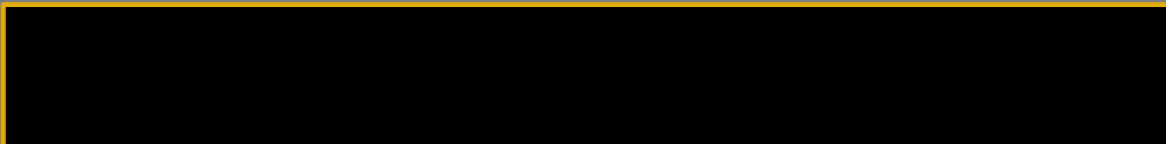

2. Carved Dado Rails

Dado – 13045
2.4m x 50mm



Dado – 13202
2.4m x 60mm



Dado – 13207
2.4m x 50mm



Dado – 13243
2.4m x 56mm

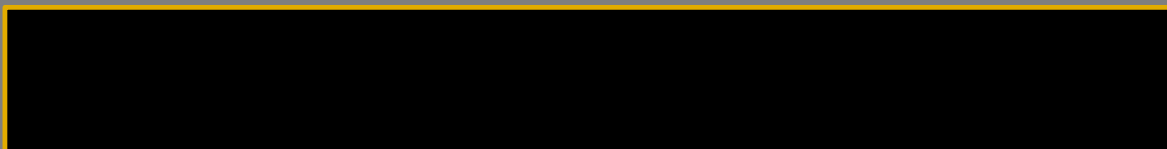

3. Stone Dado Rails

Beige Stone Dado
2.4m x 45mm



Grey Stone Dado
2.4m x 45mm

